

# BEST DEALS 2021 3

Version EN-US

**80**  
YEARS

Valid until  
**01/31/2022**  
Prices exclude VAT

## MAKE IT SMARTER

# New product: TWIN-T20

The TWIN-T20 digital display allows two measured values to be displayed simultaneously, both on the production floor and in the test laboratory.



More info on page 7



Order number	EDP number	Description	Reg. price [€]
04430014	76874	TESATRONIC TWIN-T20*	1677
04460013	76875	Stylus + holder	151

\* Design DM/212520

## Connectivity

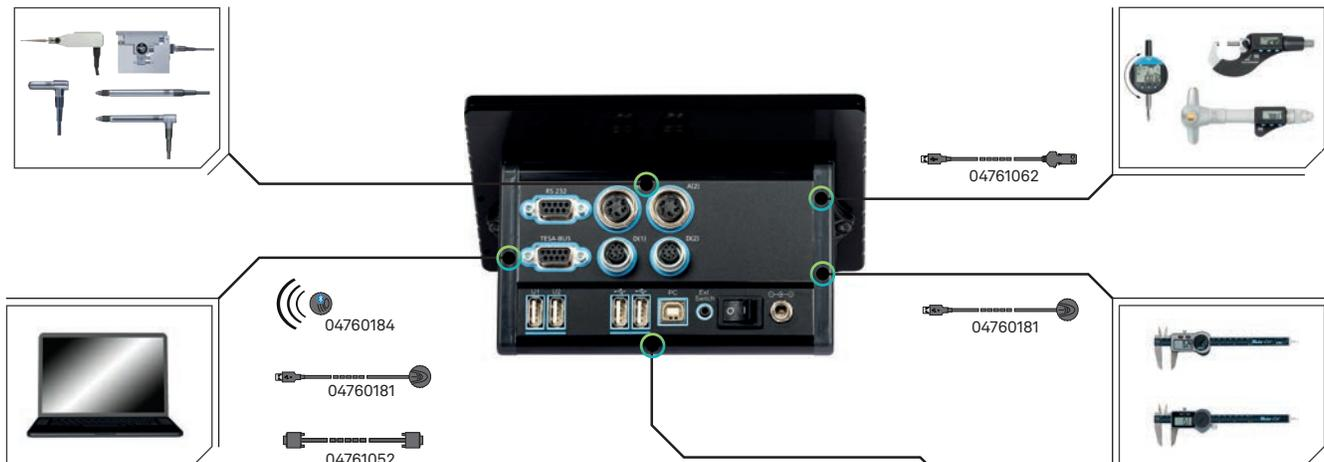

Order number	EDP number	Description	Reg. price [€]	Promo price [€]
04760181	47428	TLC-USB cable, 2m	172	137
04760184	76654	TLC-BLE emitter	66	59
4761052	27311	Extension, Sub-D 9p/f to 9p/m, 2 m	42	33
04761062	31372	OPTO-RS232 to USB cable, duplex, 2 m	286	228
04761071	47152	Foot switch, USB, 2 m	161	128
4768000	41299	Hand switch, Jack, 1.8 m	114	91
4768001	41300	Hand switch, Jack, 1.8 m	332	265



## Application example

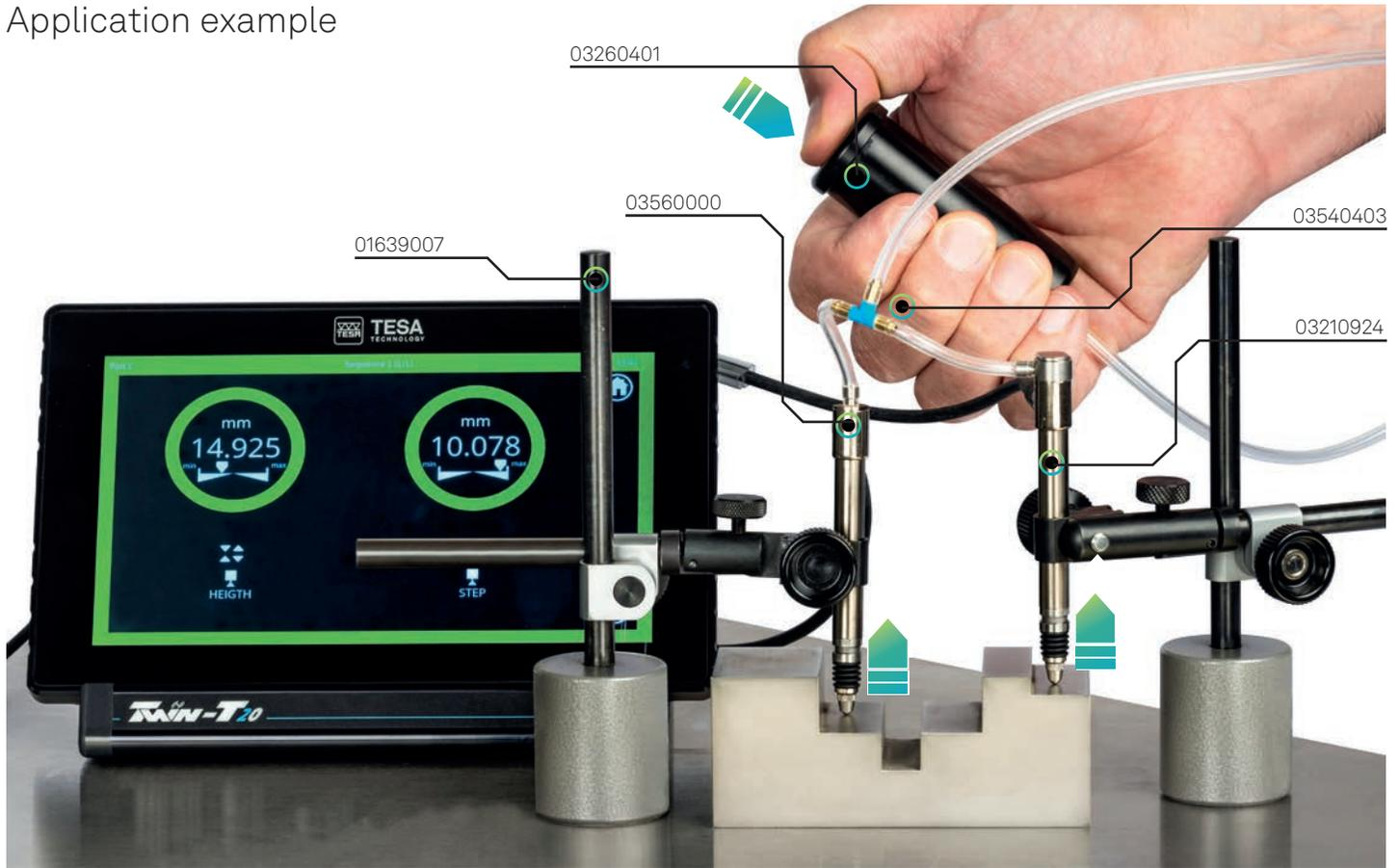

Order number	EDP number	Description	Reg. price [\$]	Promo price [\$]
32.10924	41010	Standard probes GT22, ± 1 mm, 4.3 mm bolt travel	369	<b>295</b>
01639035	20527	Measuring support, granite, 100 x 150 x 40 mm, H = 240 mm	499	<b>399</b>
01639010	76930	Mini support	81	<b>64</b>
26.60048	40893	VDE 28 probe holder, Ø 8 mm	107	<b>85</b>
16.39007	88386	UJ 15 magnetic support	194	<b>155</b>
03260401	20873	Pneumatic retraction device of the measuring bolt, manually operated	272	<b>217</b>
35.60000	41154	Straight connector, M4, for Ø 4.7/Ø 2 mm tube	26	<b>20</b>
03540403	20979	T-connector, for Ø 4.7/Ø 2 mm tube	27	<b>21</b>



“Our latest innovation for clear visualization of measured values. With this high-performance display, you will be perfectly equipped for the future to meet the high demands on performance, ease of use and multifunctional connectivity. «The Swiss army knife in its class».  
For 80 years - we make it smarter!”

**Uwe Burkardt, Marketing Director**

# TESA MICRO-HITE

With adjustable hybrid multi-user panel (touch screen + keyboard)



Easy 2D-measurement due to clear graphic visualization

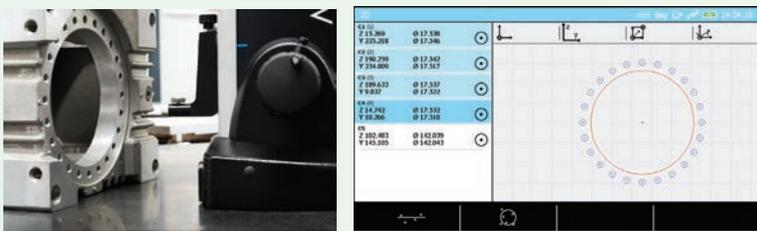

Efficient determination of the culmination points with the LED control light



After registration

**\$7,200**



Order number	EDP number	Description	Displacement	Maximum permissible errors* [μm]	Repeatability limit [μm]	Reg. price [\$]	Promo price [\$]
00730080	76625	MICRO-HITE+M 600	Motorized	1.8+2L/1000	on surface: ≤ 0.5; on arc: ≤ 1	9500	<b>7600</b>
00730077	76621	MICRO-HITE 600F	Manual w Fine Adjust	2+2L/1000	on surface: ≤ 1; on arc: ≤ 1	9500	<b>7600</b>
00730074	76640	MICRO-HITE 600	Manual	2+2L/1000	on surface: ≤ 1; on arc: ≤ 1	9000	<b>7200</b>
00760232	47410	Starter kit, 4 elements				698	<b>550</b>

\* L in mm

# Accessories for height gages

Starter kit, 4 elements



00760232

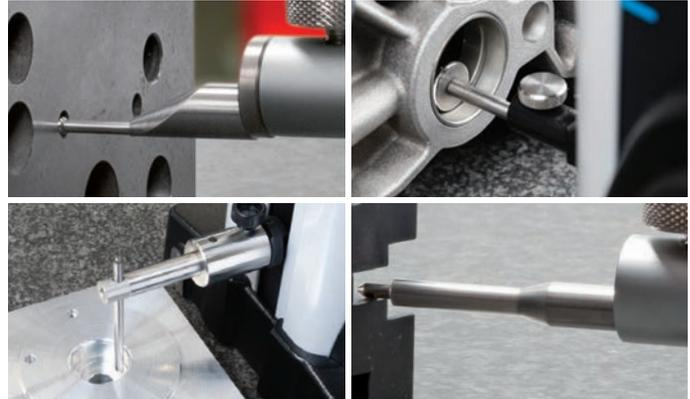

SCS-certificate included:  
Instrument ready for immediate use



Context-based help Intelligent user follow-up

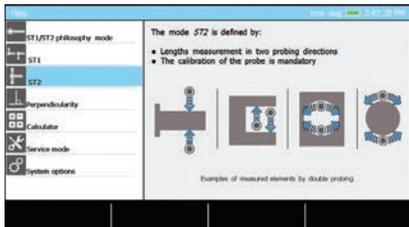

Easy data transfer to USB stick / printer / PC  
Generate a pdf measuring report directly from the program

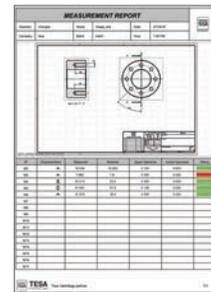

More info on page 7



"I'm proud of our worldwide reputation for highly valued height gages covering both entry level and fully-professional models, we can offer you the right solution for all of your personal measuring needs."

**Stefan Pittrich, Sales Director**

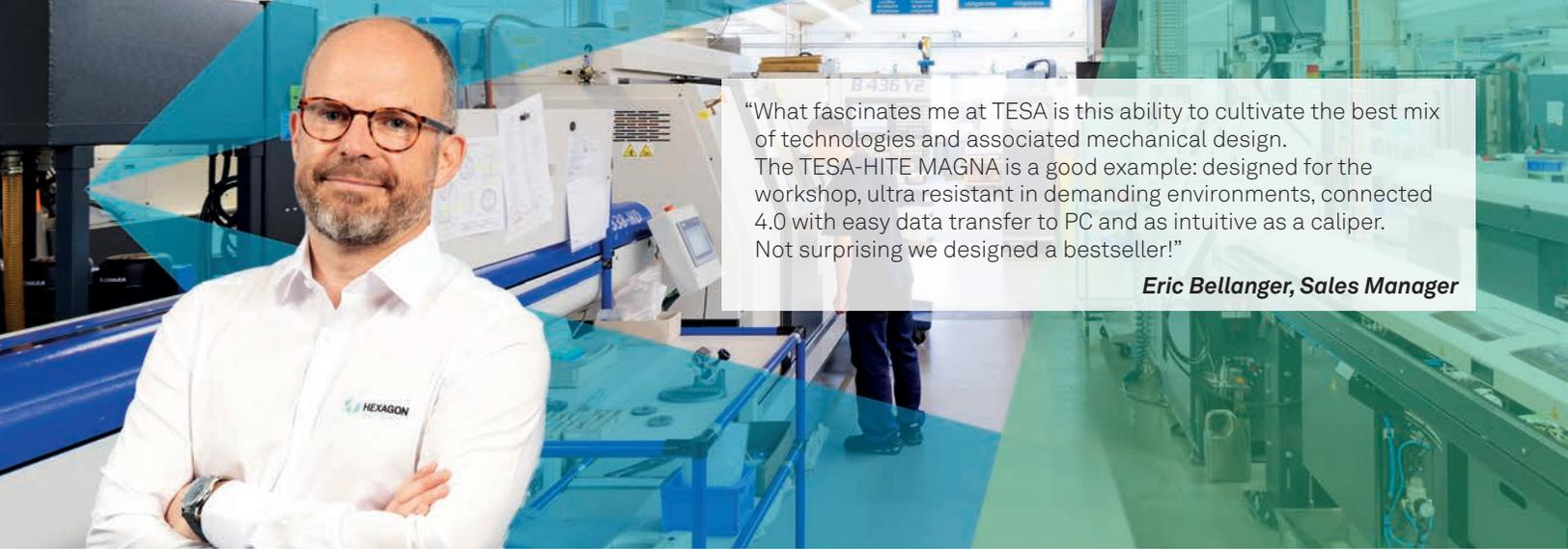

“What fascinates me at TESA is this ability to cultivate the best mix of technologies and associated mechanical design. The TESA-HITE MAGNA is a good example: designed for the workshop, ultra resistant in demanding environments, connected 4.0 with easy data transfer to PC and as intuitive as a caliper. Not surprising we designed a bestseller!”

**Eric Bellanger, Sales Manager**

# TESA-HITE MAGNA



SCS certificate included



More info on page 7



00730082



For workshops 

1D measurement 

Manual displacements 

400mm – 700mm 

TLC 

Included SCS certificate 

Measuring system: IP55  
Panel: IP65 

Order number	EDP number	Description	Maximum permissible errors [µm]	Repeatability limit [µm]	Air cushion	Reg. price [\$]	Promo price [\$]
00730082	76843	TH MAGNA 400	8	on surface: ≤ 3; on arc: ≤ 5	–	3496	<b>2790</b>
00730083	76844	TH MAGNA 700	8	on surface: ≤ 3; on arc: ≤ 5	–	4145	<b>3310</b>

# TESA connectivity

How to connect your measuring instruments

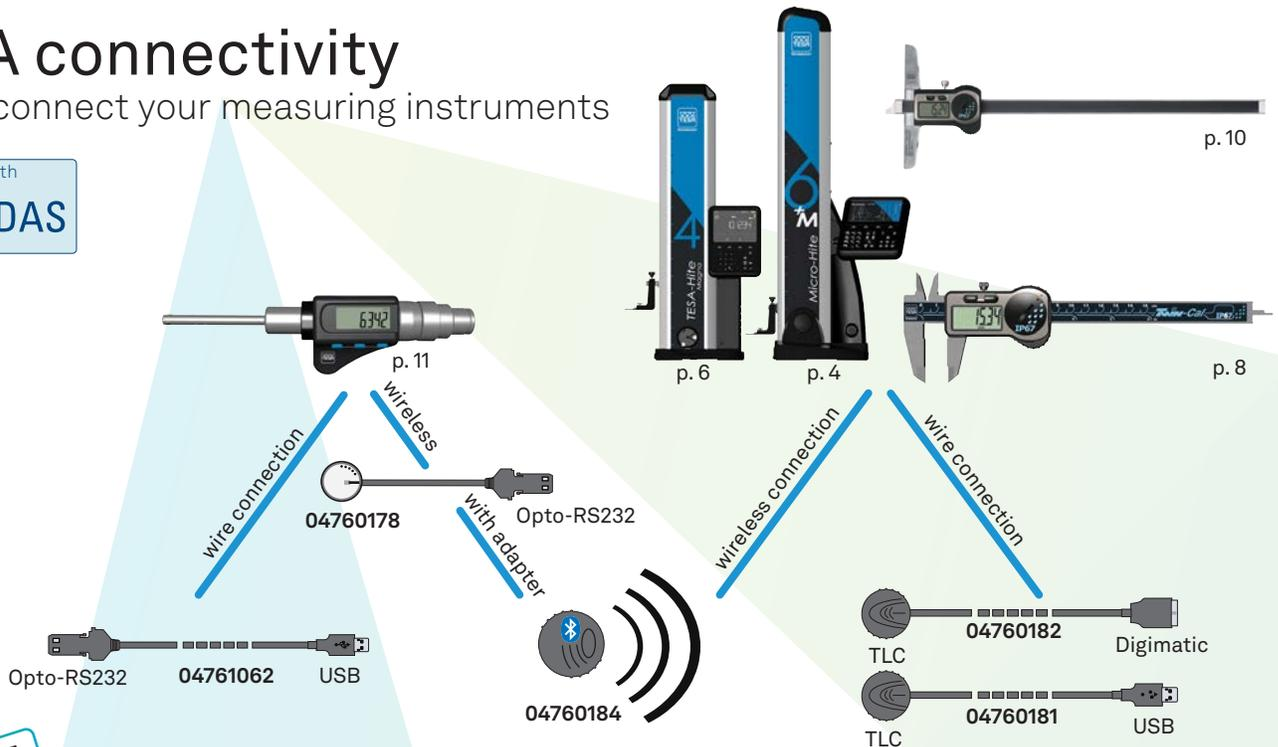

**FREE**



TESA DATA-VIEWER allows a quick and easy handling in order to export the results to a data processing program or to automatically create files in known formats such as \*.xls, \*.csv or \*.txt.

TESA DATA-VIEWER is downloadable free of charge from the TESA website!

<https://go.hexagonmi.com/DATA-VIEWERsoftware>

\*TESA instrument drivers included; Software requirements: Windows 10, 32 & 64-bit processor; Hardware requirements: Intel i5 or equivalent, 4 GB RAM, 100 MB HDD

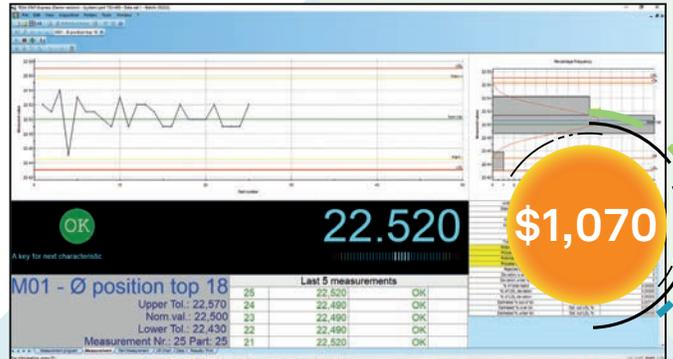

The Statistical Process Control software TESA STAT-EXPRESS software is a simple way to develop measurement programs from which it is possible to calculate in real time all the important statistical characteristics. Quick to learn, it manages also automatically the measuring reports.

Order number	EDP number	Description	Reg. price [\$]	Promo price [\$]
04760183	76653	Starter kit TLC-BLE**: Bluetooth® emitter + USB dongle* receiver + 1.5 m extension cable	114	<b>102</b>
04760184	76654	TESA TLC-BLE** Emitter	66	<b>59</b>
04760185	76655	USB dongle* receiver + 1.5 m extension cable	49,50	<b>44</b>
04760178	76651	Cable adapter Opto-TLC	128	-
04760182	47429	TESA TLC-DIGIMATIC cable	263	<b>210</b>
04760181	47428	TESA TLC-USB cable	172	<b>137</b>
04761062	31372	USB-Opto-RS232 cable	286	<b>228</b>
04981002	31451	TESA STAT-EXPRESS software	1195	<b>1070</b>
		TESA DATA-VIEWER		FREE DOWNLOAD

\*One single USB dongle can be used to connect up to 8 instruments. It's not needed with Windows 10 (Release ≥1703, Creators Update) and integrated Bluetooth® 4.0 hardware on computer

\*\*This product is only available in countries where it is officially certified. Visit our website to know the list of countries in which the TESA TLC-BLE wireless Bluetooth® emitter is available.



04760183

# TESA TWIN-CAL IP67 & TESA TWIN-CAL



More info on page 7



**THINK BIG!**  
Buy "3" TWIN-CAL IP67 and save \$9/caliper

Order number	EDP number	Description	Measuring range [in]	Thumb roller	Depth rod	Data transmission	Reg. price [\$]	Promo price [\$]
00530319	76730	TWIN-CAL IP67	6	–	■	✓	245	196
00530320	76731	TWIN-CAL IP67	6	–	●	✓	245	196
00530321	76732	TWIN-CAL IP67	6	✓	●	✓	245	196
00530322	76733	TWIN-CAL IP67	8	✓	■	✓	342	273
00530323	76734	TWIN-CAL IP67	12	✓	■	✓	468	374
00530319P	77143	TRIO-PACK TWIN-CAL IP67	6	–	■	✓	702	561
00530320P	77144	TRIO-PACK TWIN-CAL IP67	6	–	●	✓	702	561
00530094	77136	TWIN-CAL	6	✓	●	✓	162	129
00530095	77137	TWIN-CAL	8	✓	■	✓	242	193
00530096	77138	TWIN-CAL	12	✓	■	✓	325	260
00530097	77139	TWIN-CAL	6	–	■	✓	162	129
00530094P	77145	TRIO-PACK TWIN-CAL	6	✓	●	✓	463	370

**THINK CONNECTED!**  
Your connected solution for only \$255

$$\$196 + \$59 = \$255$$







“Thanks to its excellent price/performance ratio, the TWIN-CAL range is one of our customers’ favorites: its ergonomic design and connectivity are, among other things, the keys to its success.”

**Aurélie Holzer, Team Leader Internal Sales**

# TESA-CAL IP67

IP67: the highest protection at the best price.



THINK BIG!

Buy “3” TESA-CAL IP67 and save over \$5/caliper



Order number	EDP number	Description	Measuring range [in]	Thumb roller	Data transmission	Depth rod	Reg. price [\$]	Promo price [\$]
00530140	76916	TESA-CAL IP67	6	–	–	■	155	124
00530141	76917	TESA-CAL IP67	6	–	–	●	155	124
00530142	76918	TESA-CAL IP67	8	✓	–	■	236	188
00530143	76919	TESA-CAL IP67	12	✓	–	■	332	265
00530140P	77146	TRIO-PACK TESA-CAL IP67	6	–	–	■	445	356
00530141P	77147	TRIO-PACK TESA-CAL IP67	6	–	–	●	445	356

## Workshop calipers

Models with rounded measuring faces for internal dimensions and knife-edge jaws for external dimensions.



More info on page 7

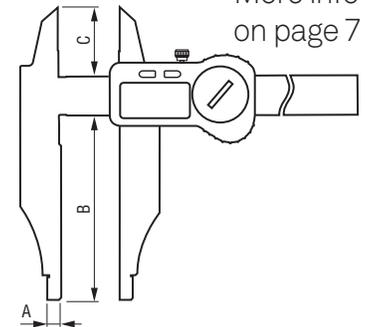

Order number	EDP number	Measuring range	A	B	C	Reg. price	Promo price
		[in]	[in]	[in]	[in]	[\$]	[\$]
00530431	45618	0 - 8	0.2	3.15	1.18	497	<b>397</b>
00530433	45620	0 - 12	0.2	3.5	1.45	589	<b>471</b>
00530434	45621	0 - 20	0.4	6	2.36	980	<b>784</b>



## Depth calipers

Models with short cut measuring face.



More info on page 7

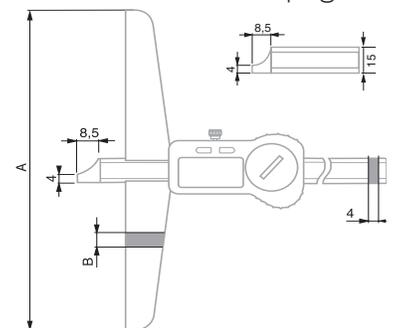

Order number	EDP number	Measuring range	A	B	Reg. price	Promo price
		[in]	[in]	[in]	[\$]	[\$]
00530441	45625	0 - 8	4	0.3	524	<b>419</b>
00530443	45627	0 - 12	6	0.3	579	<b>463</b>
00530444	45628	0 - 20	6	0.3	714	<b>571</b>



# TESA INTRIMIK digital



More info on page 7



599-290-160-1

Order number	EDP number	Measuring range [in]	Numerical scale interval [in]	Maximum permissible errors [in]	Repeatability limit [in]	Reg. price [\$]	Promo price [\$]
599-290-28-1	27499	.138 - .158	0.00005	0.00016	0.00016	1698	<b>1350</b>
599-290-30-1	27500	.158 - .178	0.00005	0.00016	0.00016	1409	<b>1120</b>
599-290-32-1	27501	.178 - .217	0.00005	0.00016	0.00016	1677	<b>1340</b>
599-290-34-1	27502	.217 - .256	0.00005	0.00016	0.00016	1678	<b>1340</b>
599-290-35-1	27503	.240 - .320	0.00005	0.00016	0.00016	1288	<b>1030</b>
599-290-42-1	27504	.320 - .400	0.00005	0.00016	0.00016	1165	<b>930</b>
599-290-50-1	27505	.400 - .480	0.00005	0.00016	0.00016	1165	<b>930</b>
599-290-60-1	27506	.430 - .550	0.00005	0.00016	0.00016	1283	<b>1020</b>
599-290-70-1	27507	.550 - .670	0.00005	0.00016	0.00016	1291	<b>1030</b>
599-290-80-1	27508	.670 - .790	0.00005	0.00016	0.00016	1304	<b>1040</b>
599-290-100-1	27509	.790 - .990	0.00005	0.00016	0.00016	1331	<b>1060</b>
599-290-120-1	27510	.990 - 1.18	0.00005	0.00016	0.00016	1363	<b>1090</b>
599-290-140-1	27511	1.18 - 1.38	0.00005	0.00016	0.00016	1372	<b>1090</b>
599-290-160-1	27512	1.38 - 1.58	0.00005	0.00016	0.00016	1399	<b>1110</b>
599-290-200-1	27513	1.58 - 1.98	0.00005	0.00016	0.00016	1470	<b>1170</b>



# BESTEST-5 SERIES Dial Test Indicators & MITI-MITE Indicator set

Order number	EDP number	Measuring range [in]	Scale interval [in]	Dial Ø [in]	Reg. price [\$]	Promo price [\$]
599-7030-5	51733	.030	.0005	1	227	<b>181</b>
599-7031-5	51734	.030	.0005	1.5	251	<b>200</b>

Order number	EDP number	Description	Reg. price [\$]	Promo price [\$]
599-849	51083	MITI-MITE & Indicator with case	504	<b>403</b>



SET PRICE  
**\$403**



599-7030-5



599-7031-5

## TESA INTERRAPID 312

Order number	EDP number	Series	Measuring range [in]	Scale interval [in]	Dial Ø [in]	Reg. price [\$]	Promo price [\$]
74.111370	42775	312B-1	.060	.0005	1.5	309	<b>247</b>
74.111371	86150	312B-2	.060	.0005	1.2	307	<b>245</b>
74.111372	41680	312B-3	.016	.0001	1.5	379	<b>303</b>
74.111377	41685	312B-1V	.060	.0005	1.5	332	<b>265</b>



Stylus insert with angular position of 12°

All TESA INTERRAPID 312 models are designed to give a true reading when the angle between the stylus and the workpiece surface is 12° (see illustration).



74.111370

# BROWN & SHARPE classic series



\$610

00180080

0 - 4 in



\$105

00180070



\$137

599-579-4



\$137

599-579-5



\$66

00580101



FROM \$93

00530506



\$115

01.60201

Order number	EDP number	Description	Measuring range		Resolution		Reg. price	Promo price
			[in]		[in]	[mm]		
00180070	76832	Enamel frame micrometer with straight line graduations	0 - 1		.0001		132	105
00180071	76833	Enamel frame micrometer with straight line graduations	1 - 2		.0001		144	115
00180072	76834	Enamel frame micrometer with straight line graduations	2 - 3		.0001		150	120
00180073	76835	Enamel frame micrometer with straight line graduations	3 - 4		.0001		156	124
00180077	76839	Enamel frame micrometer set, w/o standards	0 - 3		.0001		479	383
00180078	76840	Enamel frame micrometer set, with standards	0 - 3		.0001		576	460
00180079	76841	Enamel frame micrometer set, w/o standards	0 - 4		.0001		619	495
00180080	76842	Enamel frame micrometer set, with standards	0 - 4		.0001		763	610
01.60201	39547	MICROMETER STAND	-	-	-	-	144	115
599-579-4	51774	DIAL-CAL® dial caliper with silver dial face	0 - 6		.001		172	137
599-579-5	51879	DIAL-CAL® dial caliper with black dial face	0 - 6		.001		172	137
00580101	76853	B&S vernier caliper 6 in 0.05 mm - .001 in	0 - 6		.001	0.05	83	66
00530506	76860	Workshop vernier caliper 8 in 0.05 mm - 1/28 in	0 - 8		1/128	0.05	117	93
00530522	76861	Workshop vernier caliper 12 in 0.05 mm - 1/28 in	0 - 12		1/128	0.05	167	133
00530542	76862	Workshop vernier caliper 20 in 0.05 mm - 1/28 in	0 - 20		1/128	0.05	428	342

# TESA CLINOBEVEL 3 INCLINOMETER

Robust and easy to use, the TESA CLINOBEVEL 3 is a top of the range portable precision inclinometer. It's available in aluminium or cast iron.



05330210

Cast iron model, rust protected



Order number	EDP number	Description	Measuring range [°]	Resolution [mm/m]	Reg. price [\$]	Promo price [\$]
05330210	76863	TESA CLINOBEVEL 3 60 DEG IRON	± 60	0.025	4922	<b>4420</b>
05330211	76864	TESA CLINOBEVEL 3 60 DEG ALU	± 60	0.025	4922	<b>4420</b>
05330214	76940	TESA CLINOBEVEL 3 1 DEG IRON	± 1	0.001	10920	<b>9820</b>

# TESA CLINOBEVEL 1 USB

Portable and compact instrument to measure horizontal and vertical inclination up to ± 45°. Light, manageable and battery operated it can be used directly on the piece to be measured.



05330204

Order number	EDP number	Description	Measuring range [°]	Reg. price [\$]	Promo price [\$]
05330203	36119	CLINOBEVEL1 USB SET (with CLINOSOFT software and USB cable)	± 45	2182	<b>1960</b>
05330204	76865	CLINOBEVEL1 USB	± 45	1964	<b>1760</b>

# TESA RUGOSURF

RUGOSURF 20: 15 most used roughness parameters.  
 RUGOSURF 90G: 49 roughness parameters.



Included: 2µm stylus tip radius

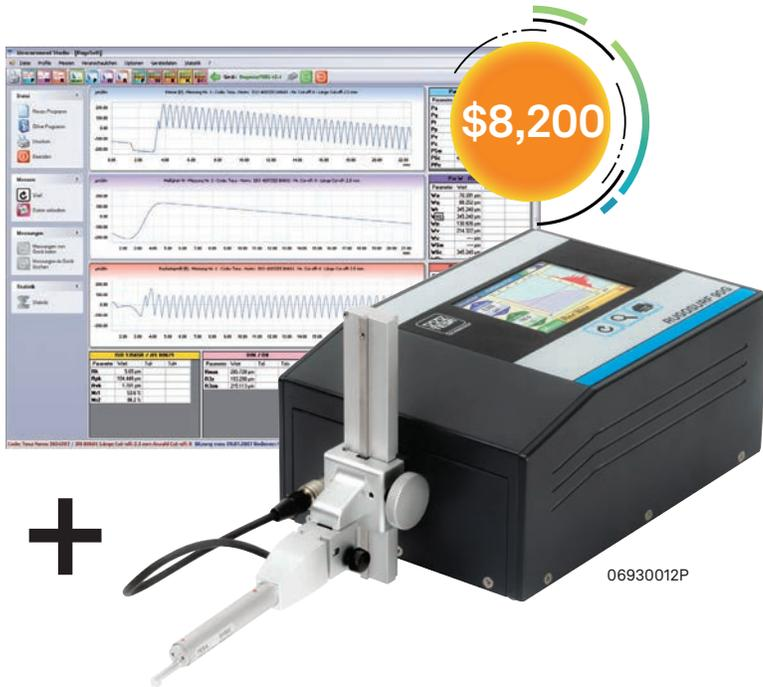

06930012P



06930013

Easy to use and ideal for shop floor

SET for advanced tasks in roughness testing

Order number	EDP number	Description	Reg. price	Promo price
			[\$]	[\$]
06930013	47126	TESA RUGOSURF 20	2271	<b>2040</b>
06930012	29441	TESA RUGOSURF 90G	8090	<b>7280</b>
06930012P	35356	TESA RUGOSURF 90G + MEASUREMENT STUDIO software + PC cable	9117	<b>8200</b>

Free download Data Connection tool: <https://go.hexagonmi.com/DataConnectionTool>

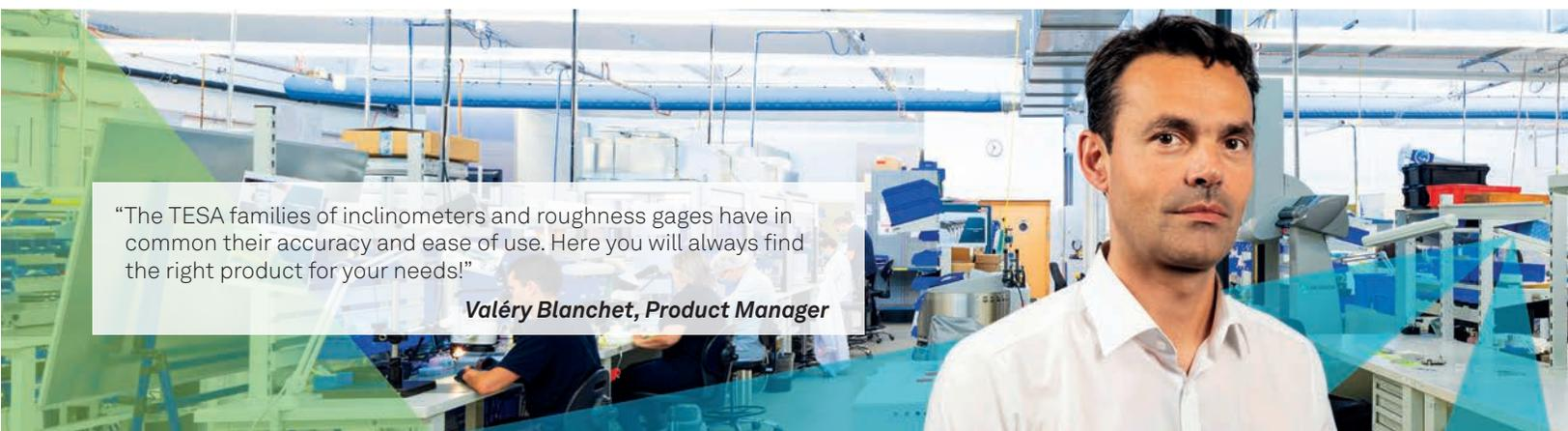

“The TESA families of inclinometers and roughness gages have in common their accuracy and ease of use. Here you will always find the right product for your needs!”

**Valéry Blanchet, Product Manager**

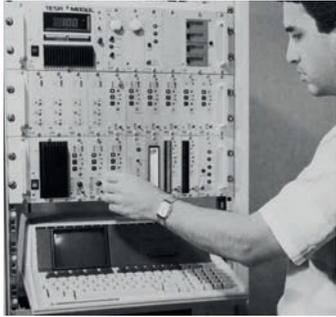
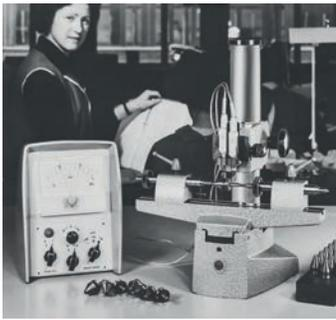

"I'm very proud of TESA for this 80th anniversary. It's an incredible legacy! For all these years TESA has been at the forefront of innovation in metrology. Today we continue to serve millions of customers worldwide with one promise: the quality of our products guarantees the quality of YOUR products!"

**Fabrice Schertenleib, Managing Director**



We reserve the right to make changes to our products, especially due to technical improvements and further developments. All illustrations and technical data are therefore without guarantee. All prices shown are non-binding price recommendations.